

Product range
Telescopic Stair
Landing Connectors

Product options
TSS 81-30, RVK 101-30
plus REDiBOX® Permanent
Recess Former (PIN)

Layout option 6
Integral flight and two
landings with connectors
at both ends

Key to dimensions

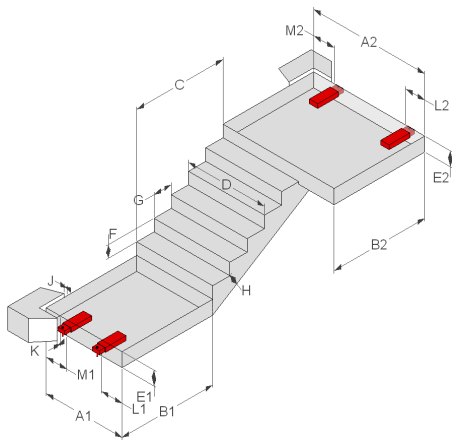

For alternative layouts, go to
invisibleconnections.co.uk
or call us for advice

Invisible Connections Ltd
Unit 6, Thame Forty
Jane Morbey Road
Thame, Oxfordshire OX9 3RR
+44 (0)1844 266000
sales@invisibleconnections.co.uk
invisibleconnections.co.uk

Technical Enquiry Form

Telescopic Stair Landing Connectors Layout Option 6

Please provide below the contact information, project details, dimensions and load data.

Contact and project details

Contact name

Company

Telephone

Email

Project name

Project location

Main contractor

Precaster

Stair core reference

Drawing number(s)

Walls start date (estimate)

Stairs start date (estimate)

Dimensions

See A-M on image to left. Please enter dimensions in mm.

A1 Landing length G Going

A2 Landing length H Waist

B1 Landing width J Air gap (sides)

B2 Landing width K Air gap (rear)

C Flight length L1 Connector position

D Flight width L2 Connector position

E1 Landing thickness M1 Connector position

E2 Landing thickness M2 Connector position

F Rise

Load data

(Examples)

Finishes on landing *(0.5 kN/sqm)*

Finishes on flight *(0.2 kN/sqm)*

Live load *(4 kN/sqm)*

Using the above information we will conduct an initial assessment of the application and advise suitable product selection, supported by calculations as required.

Please email completed enquiry form and any supporting drawings to technical@invisibleconnections.co.uk

For technical and practical advice call +44 (0)1844 266000